

Options available for GDSTAS

Load ranges

50kN	<input checked="" type="checkbox"/>	500kN	<input checked="" type="checkbox"/>
100kN	<input checked="" type="checkbox"/>	250kN	<input checked="" type="checkbox"/>

Cell or back pressure ranges

500kPa	<input checked="" type="checkbox"/>	16MPa	<input checked="" type="checkbox"/>
1000kPa	<input checked="" type="checkbox"/>	20MPa	<input checked="" type="checkbox"/>
2000kPa	<input checked="" type="checkbox"/>	32MPa	<input checked="" type="checkbox"/>
3000kPa	<input checked="" type="checkbox"/>	64MPa	<input checked="" type="checkbox"/>
4000kPa	<input checked="" type="checkbox"/>	128MPa	<input checked="" type="checkbox"/>
8000kPa	<input checked="" type="checkbox"/>	150MPa	<input checked="" type="checkbox"/>

Triaxial cells from:

1700kPa	<input checked="" type="checkbox"/>	to 128MPa	<input checked="" type="checkbox"/>
---------	-------------------------------------	-----------	-------------------------------------

for sizes:

38mm	<input checked="" type="checkbox"/>	to 300mm	<input checked="" type="checkbox"/>
------	-------------------------------------	----------	-------------------------------------

Triaxial Automated System (GDSTAS) including ELTAS, STDTAS, ADVTAS and HPTAS

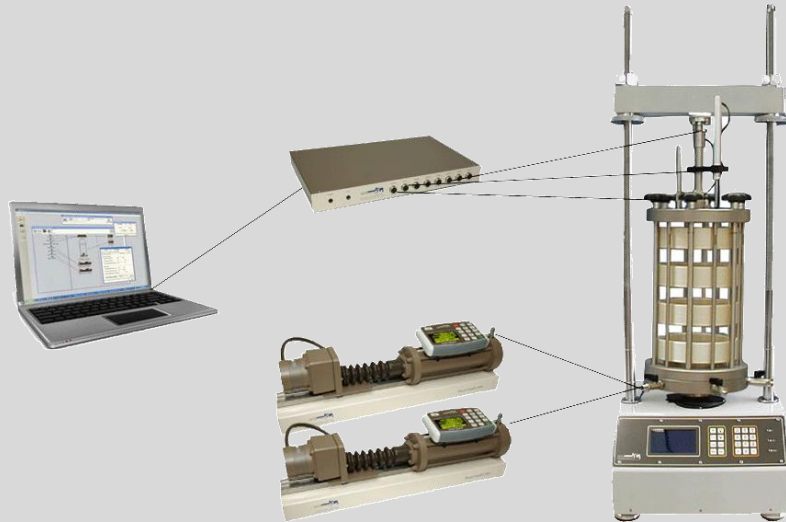

What is it?

The GDS Triaxial Automated System (GDSTAS) is a load frame-based triaxial testing system which may be configured exactly to the customers specification and budget. Using the GDS range of load frames, triaxial cells, pressure systems and the GDSLAB software, the basic system can be configured for low cost multi-station commercial testing right through to high range rock testing at research level. Using GDSLAB with optional software modules, GDSTAS can run advanced tests such as stress paths, slow cyclic and K0, all under PC control.

This system can be configured using any GDS devices, from a 50kN to 500kN load frame and from a 500kPa to 150MPa pressure controller.

Overview

The GDS Triaxial Automated System, GDSTAS, has been designed to comply with international standards of test execution and data presentation, and to qualify for national laboratory accreditation schemes.

The system is controlled by the user's PC running MS Windows® and GDSLAB software.

The operator chooses the type of test from a test menu (eg U-U, C-U, multi-stage, stress path etc) and then enters the test parameters (of cell pressure, back pressure, testing rate and so on) and test termination conditions.

The test then proceeds automatically with all test data being saved to a file. On-line graphics are presented with up to three graphs displayed together with a block of current live test data. Tests can proceed overnight and during weekends and holidays. To enable spot-verification, all electronic measurements may be duplicated by mechanical gauges.

The computer directly controls the cell pressure, back pressure and testing rate. In addition to logging these parameters to the PC hard drive, the computer also logs axial displacement, axial load, pore pressure and volume change. Of course, additional transducers may be easily configured and logged during the test.

Technical specification

- computer-automated control of testing - not just data logging
- dedicated computer to each test station or multiple stations per PC
- MS Windows® software (GDSLAB) for test control and post-test processing
- cell pressure and back pressure truly independent
- spot-verification option
- well defined calibration procedures using Budenberg dead weight tester
- compliance with international standards
- future proof fully expandable software to allow additional testing or hardware to be incorporated at any time

System elements

The fundamental system hardware elements are shown in Fig. 1 below. The actual hardware used may be chosen to suit your testing and budgetary requirements. The more common arrangements are as follows:

- Enterprise Triaxial Automated System (**ELTAS**) which is based on 1MPa Enterprise Pressure/Volume Controller (ELDPC)
- Standard Triaxial Automated System (**STDTAS**) which is based on 3MPa Standard Pressure/Volume Controller (STDDPC)
- Advanced Triaxial Automated System (**ADV TAS**) which is based on 2MPa Advanced Pressure/Volume Controller (ADV DPC)
- High Pressure Triaxial Automated System (**HPTAS**) which is based on High Pressure Controllers ($\geq 16\text{MPa}$)

Each system may be chosen from a range of hardware supplied by GDS as follows (1-5):

1) Load frames

- 50kN and 100kN Velocity controlled devices with serial PC connectivity.
- 100kN, 250kN, 500kN, 750kN, 1000kN velocity, position and direct load feedback control with serial or IEEE PC connectivity.

2) Triaxial cells

- 1700kPa, specimens up to 50, 100 or 150mm (load frames $> 50\text{kN}$ for 150mm cell due to size)
- 3400kPa, specimens up to 77mm
- 14MPa, specimens up to 50 or 100mm
- 20MPa, specimens up to 70mm
- 64MPa, specimens up to 54mm or 100mm
- 128MPa, specimens up to 50mm

3) Pressure/volume controllers

The cell pressure and back pressure controllers may be mixed and matched. There is the Enterprise Level Pressure/Volume Controller (ELDPC – see Fig. 2), with a pressure range to 1 MPa, USB connectivity and 200 cc volumetric capacity.



Fig. 2 The ELDPC

A Standard Pressure/Volume Controller (STDDPC – see Fig. 3), with pressure ranges from 1 to 4MPa, USB connectivity and 200 cc volumetric capacity.



Fig. 3 The STDDPC

Or there is the Advanced Pressure/Volume Controller (ADV DPC – see Fig. 4) with pressure ranges of 2MPa, 3MPa, 4MPa, 8MPa, 16MPa, 32MPa, 64MPa and 128MPa with serial or IEEE PC connectivity and 200cc volumetric capacity. (Also, the ADV DPC 2MPa controller can be bought as 1000cc volumetric capacity item).



Fig. 4 The ADV DPC

The back pressure controller which applies back pressure, also measures volume change of the test specimen.

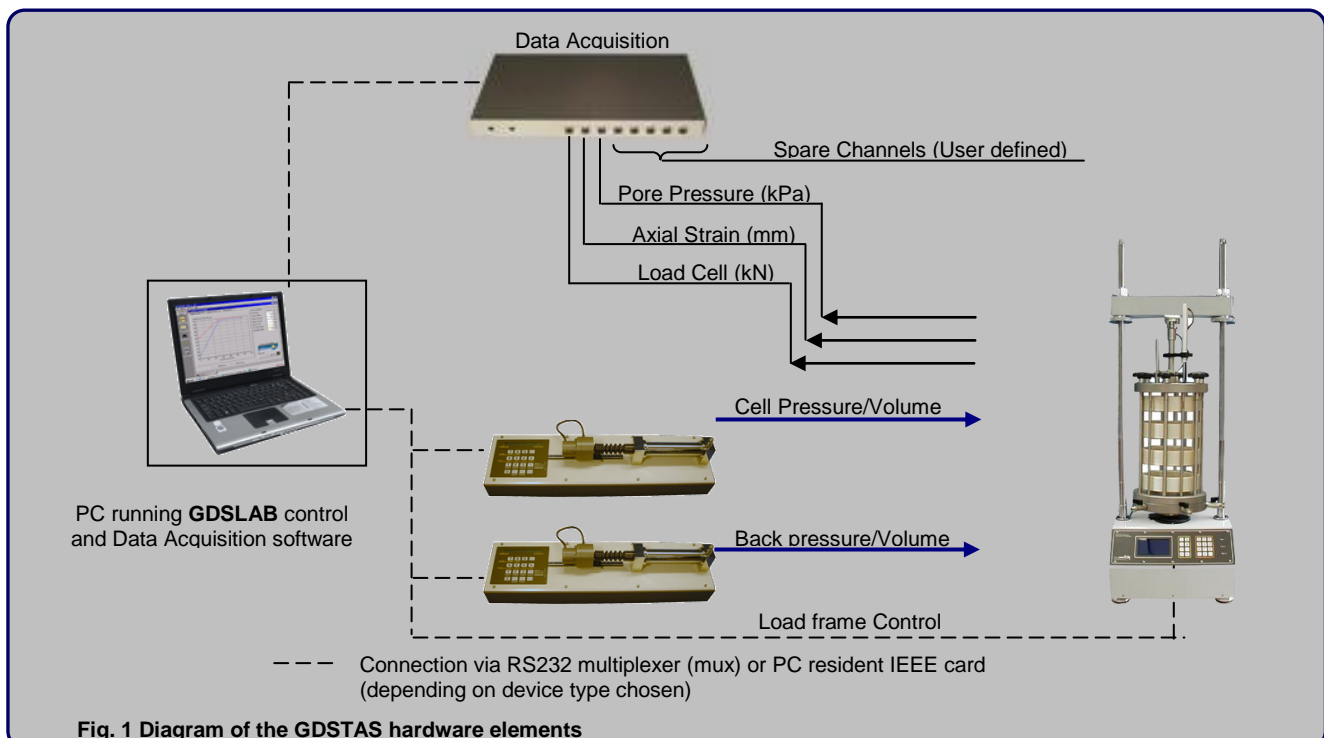

Fig. 1 Diagram of the GDSTAS hardware elements

4) Data acquisition devices

The standard GDS 8 channel data acquisition device, known as the "serial data pad", may be used within any of the system combinations. This 16 bit device has 8 computer controlled gain ranges, specifically designed to suit transducers used in a triaxial test. i.e.

- +/-10mV, +/-20mV, +/-30mV (load cells)
- +/-100mV, +/-200mV (pressure transducers)
- +/- 1V, +/- 5V, +/- 10V (displacement transducers)

5) Connecting devices

The system controller is any PC that runs MS Windows® v9x or above (Windows XP preferred). GDSLAB software is capable of running the hardware provided it can be connected to the PC. Multiple serial (RS232) devices may be connected using the GDS 4 channel multiplexer (mux), and up to 16 IEEE devices may be connected via a PC-resident IEEE card. The type of connectivity is of course determined by the device being connected

GDSLAB control software

The GDSLAB control and acquisition software is a highly developed, yet extremely flexible software platform. Starting with the Kernel module and the ability to perform data acquisition only, additional modules may be chosen for your testing requirements. Some currently available modules are as follows:

- SATCON (saturation and consolidation)
- standard triaxial
- stress path testing (p, q and s, t)
- advanced loading tests
- unsaturated testing
- K0 consolidation
- permeability

GDSLAB has the ability to be configured to your hardware of choice, no matter how unique the arrangement. A text file (*.ini) or initialisation file is created that describes the hardware connectivity to the PC. The hardware layout is available in graphical format via the GDSLAB 'object display'. This makes setting up the devices and checking the connectivity extremely simple (see Fig. 5).

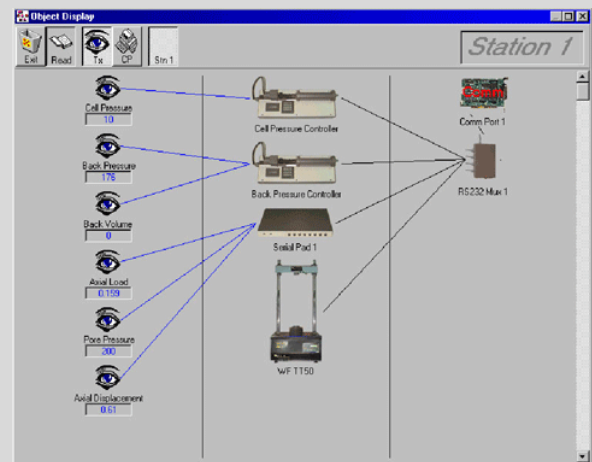

Fig. 5 Object display showing a standard STDTAS arrangement

For further information on GDSLAB, please refer to the dedicated GDSLAB datasheet.

GDSLAB REPORTS presentation software

GDSLAB REPORTS is a triaxial, shearbox and oedometer presentation package to National Standards (eg. BS 1377). This program is used to present data which is saved in a GDSLAB data file or input by hand.

GDSLAB REPORTS is a program which combines the simplicity of a MS Windows® user interface, with the power of MS Excel®. Data obtained using GDSLAB control and data acquisition software may be selected, viewed and manipulated where necessary (see Fig. 6) before being exported directly as an MS Excel® spreadsheet.

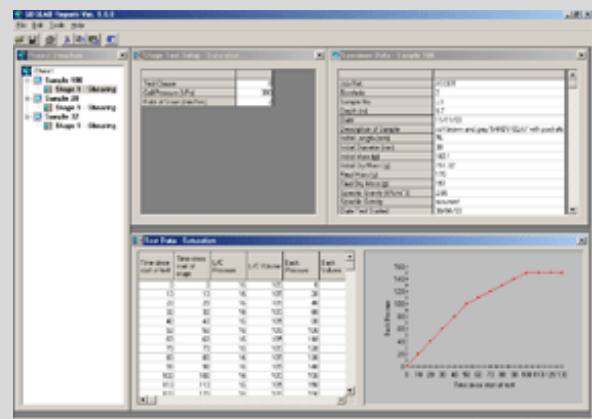

Fig. 6 GDSLAB Reports user interface

For further information on GDSLAB REPORTS, please refer to the dedicated GDSLAB datasheet.

Upgrade to local strain measurement

Any GDSTAS system may be upgraded to perform Local Strain measurement using either Hall Effect or LVDT transducers (see Fig. 7). Both device types enable axial and radial deformation to be measured directly on the test specimen via lightweight aluminum holders.

Hall Effect transducers may be used in water up to 1700kPa. LVDT transducers come in 2 versions:

- **low pressure** (up to 3500 kPa) version for use in water
- **high pressure** (up to 200 MPa) version for use in non-conducting oil

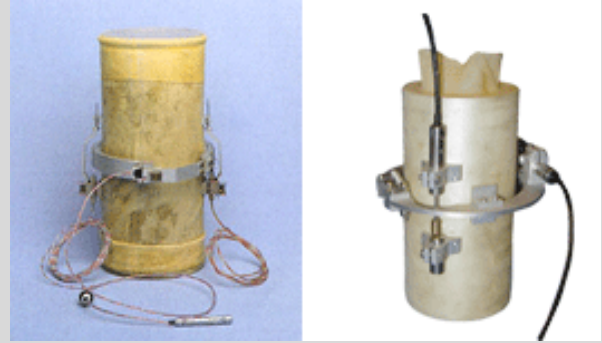

Fig. 7 Hall Effect and LVDT local strain transducers

For further information on local strain measurement, please refer to the dedicated Hall Effect Local Strain and LVDT Local Strain datasheets.

Upgrade to unsaturated testing

Any GDSTAS system may be upgraded to perform unsaturated triaxial testing with the addition of the following items:

- unsaturated pedestal with high air entry porous stone
- 1000cc Advanced Pressure/Volume Controller (for application of pore air pressure and measurement of air volume change) as in Fig. 8.

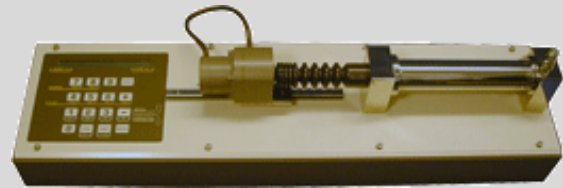

Fig. 8 1000cc Advanced Pressure/Volume Controller (ADVDPCC)

For further information on unsaturated testing, including further unsaturated testing methods, please refer to the dedicated Unsaturated datasheet.

Upgrade to bender element testing

Any GDSTAS system may be upgraded to perform P and S wave bender element testing with the addition of the following items:

- bender element pedestal with bender element insert
- bender element top-cap with bender element insert
- high-speed data acquisition card
- signal conditioning unit which includes amplification of source and received signals (P and S-wave) with user controlled gain levels (via software).

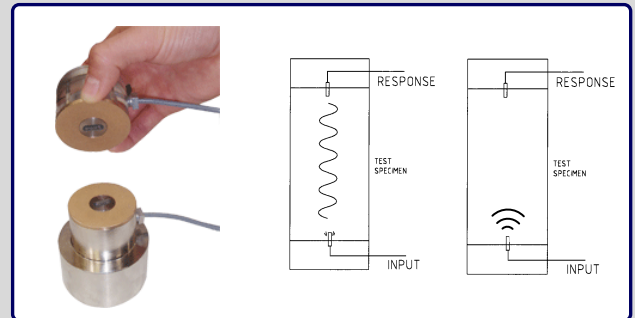

Fig. 9 P and S wave elements

For further information on bender element testing, please refer to the dedicated Bender Element Testing datasheet.

Why buy GDSTAS?

- Volume resolution = 1mm³
- Flexibility in the capacity of the system (specimen size, load, pressures etc) ensures a system is created to specifically suit the testing required and the budget.
- GDS worldwide technical support.

Due to continued development, specifications may change without notice.